

TL750M, TL751M SERIES LOW-DROPOUT VOLTAGE REGULATORS

SLVS021H – JANUARY 1988 – REVISED JANUARY 2000

- Very Low Dropout Voltage, Less Than 0.6 V at 750 mA
- Low Quiescent Current
- TTL- and CMOS-Compatible Enable on TL751M Series
- 60-V Load-Dump Protection
- Overvoltage Protection
- Internal Thermal Overload Protection
- Internal Overcurrent-Limiting Circuitry

description

The TL750M and TL751M series are low-dropout positive voltage regulators specifically designed for battery-powered systems. The TL750M and TL751M series incorporate onboard overvoltage and current-limiting protection circuitry to protect the devices and the regulated system. Both series are fully protected against 60-V load-dump and reverse-battery conditions. Extremely low quiescent current, even during full-load conditions, makes the TL750M and TL751M series ideal for standby power systems.

The TL750M and TL751M series offers 5-V, 8-V, 10-V, and 12-V options. The TL751M series has the addition of an enable (ENABLE) input. The ENABLE input gives the designer complete control over power up, allowing sequential power up or emergency shutdown. When ENABLE is high, the regulator output is placed in the high-impedance state. The ENABLE input is TTL- and CMOS-compatible.

The TL750MxxC and TL751MxxC are characterized for operation over the virtual junction temperature range 0°C to 125°C.

AVAILABLE OPTIONS

T _J	V _O TYP (V)	PACKAGED DEVICES				CHIP FORM (Y)
		HEAT-SINK MOUNTED (3-PIN) (KC)	PLASTIC FLANGE MOUNT (KTE)	PLASTIC FLANGE MOUNT (KTG)	PLASTIC FLANGE MOUNT (KTP)	
0°C to 125°C	5	TL750M05CKC	TL750M05CKTE	TL751M05CKTG	TL750M05CKTPR	TL750M05Y
	8	TL750M08CKC	TL750M08CKTE	TL751M08CKTG	TL750M08CKTPR	TL750M08Y
	10	TL750M10CKC	TL750M10CKTE	TL751M10CKTG	TL750M10CKTPR	TL750M10Y
	12	TL750M12CKC	TL750M12CKTE	TL751M12CKTG	TL750M12CKTPR	TL750M12Y

The KTE and KTG packages are available taped and reeled. The KTP is only available taped and reeled. Add the suffix R to device type (e.g., TL750M05CKTER). Chip forms are tested at 25°C.



Please be aware that an important notice concerning availability, standard warranty, and use in critical applications of Texas Instruments semiconductor products and disclaimers thereto appears at the end of this data sheet.

PRODUCTION DATA information is current as of publication date. Products conform to specifications per the terms of Texas Instruments standard warranty. Production processing does not necessarily include testing of all parameters.

 **TEXAS
INSTRUMENTS**

POST OFFICE BOX 655303 • DALLAS, TEXAS 75265

Copyright © 2000, Texas Instruments Incorporated

TL750M, TL751M SERIES LOW-DROPOUT VOLTAGE REGULATORS

SLVS021H – JANUARY 1988 – REVISED JANUARY 2000

TL750M . . . KC PACKAGE†
(TOP VIEW)

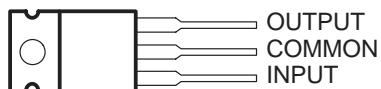

TO-220AB

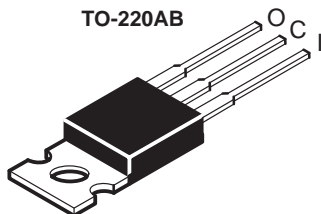

TL750M . . . KTE PACKAGE†
(TOP VIEW)

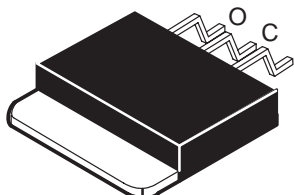
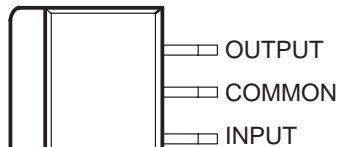

TL750M . . . KTP PACKAGE†
(TOP VIEW)

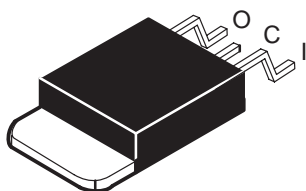
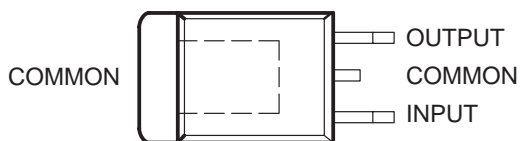

TL751M . . . KTG PACKAGE†
(TOP VIEW)

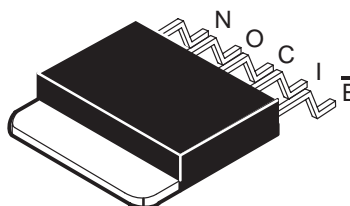
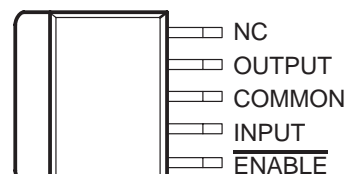

† The common terminal is in electrical contact with the mounting base.
NC – No internal connection

TL751Mxx functional block diagram

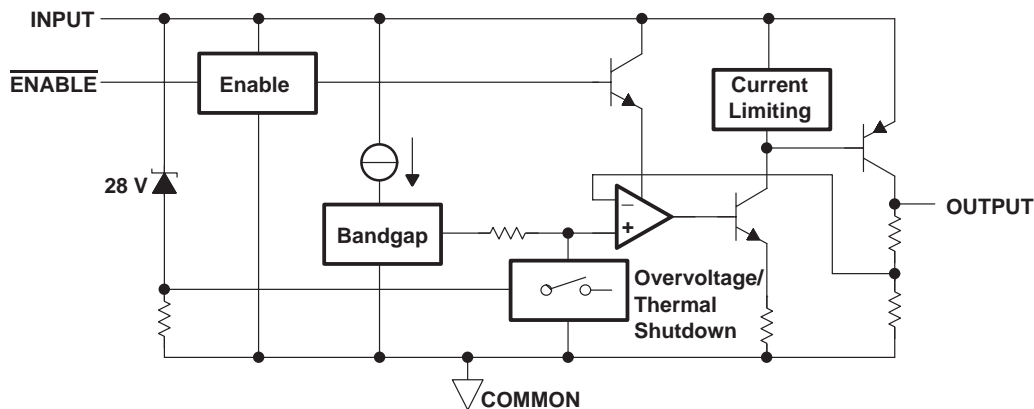

DEVICE COMPONENT COUNT	
Transistors	46
Diodes	14
Resistors	44
Capacitors	4
JFETs	1
Tunnels (emitter R)	2

TL750M, TL751M SERIES LOW-DROPOUT VOLTAGE REGULATORS

SLVS021H – JANUARY 1988 – REVISED JANUARY 2000

absolute maximum ratings over virtual junction temperature range (unless otherwise noted)†

Continuous input voltage	26 V
Transient input voltage (see Figure 3)	60 V
Continuous reverse input voltage	-15 V
Transient reverse input voltage: t = 100 ms	-50 V
Package thermal impedance, θ_{JA} (see Notes 1 and 2):	
KC package	22°C/W
KTE package	23°C/W
KTG package	23°C/W
KTP package	28°C/W
Virtual junction temperature range, T_J	0°C to 150°C
Lead temperature 1,6 mm (1/16 inch) from case for 10 seconds	260°C
Storage temperature range, T_{stg}	-65°C to 150°C

† Stresses beyond those listed under “absolute maximum ratings” may cause permanent damage to the device. These are stress ratings only, and functional operation of the device at these or any other conditions beyond those indicated under “recommended operating conditions” is not implied. Exposure to absolute-maximum-rated conditions for extended periods may affect device reliability.

- NOTES:
- Maximum power dissipation is a function of $T_J(\max)$, θ_{JA} , and T_A . The maximum allowable power dissipation at any allowable ambient temperature is $P_D = (T_J(\max) - T_A)/\theta_{JA}$. Operating at the absolute maximum T_J of 150°C can impact reliability. Due to variation in individual device electrical characteristics and thermal resistance, the built-in thermal overload protection may be activated at power levels slightly above or below the rated dissipation.
 - The package thermal impedance is calculated in accordance with JESD 51.

recommended operating conditions

		MIN	MAX	UNIT
Input voltage range, V_I	TL75xM05	6	26	V
	TL75xM08	9	26	
	TL75xM10	11	26	
	TL75xM12	13	26	
High-level $\overline{\text{ENABLE}}$ input voltage, V_{IH}	TL751Mxx	2	15	V
Low-level $\overline{\text{ENABLE}}$ input voltage, V_{IL}	TL751Mxx	0	0.8	V
Output current range, I_O	TL75xMxxC		750	mA
Operating virtual junction temperature range, T_J	TL75xMxxC	0	125	°C

electrical characteristics, $V_I = 14$ V, $I_O = 300$ mA, $T_J = 25^\circ\text{C}$

PARAMETER	TL751MXXX			UNIT
	MIN	TYP	MAX	
Response time, $\overline{\text{ENABLE}}$ to output		50		μs

TL750M, TL751M SERIES LOW-DROPOUT VOLTAGE REGULATORS

SLVS021H – JANUARY 1988 – REVISED JANUARY 2000

electrical characteristics, $V_I = 14\text{ V}$, $I_O = 300\text{ mA}$, $\overline{\text{ENABLE}}$ at 0 V for TL751M05, $T_J = 25^\circ\text{C}$ (unless otherwise noted) (see Note 3)

PARAMETER	TEST CONDITIONS	TL750M05C TL751M05C			UNIT
		MIN	TYP	MAX	
Output voltage		4.95	5	5.05	V
	$T_J = 0^\circ\text{C to } 125^\circ\text{C}$	4.9		5.1	
Input voltage regulation	$V_I = 9\text{ V to } 16\text{ V}$, $I_O = 250\text{ mA}$		10	25	mV
	$V_I = 6\text{ V to } 26\text{ V}$, $I_O = 250\text{ mA}$		12	50	
Ripple rejection	$V_I = 8\text{ V to } 18\text{ V}$, $f = 120\text{ Hz}$	50	55		dB
Output voltage regulation	$I_O = 5\text{ mA to } 750\text{ mA}$		20	50	mV
Dropout voltage	$I_O = 500\text{ mA}$			0.5	V
	$I_O = 750\text{ mA}$			0.6	
Output noise voltage	$f = 10\text{ Hz to } 100\text{ kHz}$		500		μV
Bias current	$I_O = 750\text{ mA}$		60	75	mA
	$I_O = 10\text{ mA}$			5	
Bias current (TL751M05C and TL751M05Q only)	$\overline{\text{ENABLE}} V_{IH} \geq 2\text{ V}$			200	μA

NOTE 3: Pulse-testing techniques maintain the junction temperature as close to the ambient temperature as possible. Thermal effects must be taken into account separately. All characteristics are measured with a 0.1- μF capacitor across the input and a 10- μF tantalum capacitor on the output, with equivalent series resistance within the guidelines shown in Figure 3.

electrical characteristics, $V_I = 14\text{ V}$, $I_O = 300\text{ mA}$, $\overline{\text{ENABLE}}$ at 0 V for TL751M08, $T_J = 25^\circ\text{C}$ (unless otherwise noted) (see Note 3)

PARAMETER	TEST CONDITIONS	TL750M08C TL751M08C			UNIT
		MIN	TYP	MAX	
Output voltage		7.92	8	8.08	V
	$T_J = 0^\circ\text{C to } 125^\circ\text{C}$	7.84		8.16	
Input voltage regulation	$V_I = 10\text{ V to } 17\text{ V}$, $I_O = 250\text{ mA}$		12	40	mV
	$V_I = 9\text{ V to } 26\text{ V}$, $I_O = 250\text{ mA}$		15	68	
Ripple rejection	$V_I = 11\text{ V to } 21\text{ V}$, $f = 120\text{ Hz}$	50	55		dB
Output voltage regulation	$I_O = 5\text{ mA to } 750\text{ mA}$		24	80	mV
Dropout voltage	$I_O = 500\text{ mA}$			0.5	V
	$I_O = 750\text{ mA}$			0.6	
Output noise voltage	$f = 10\text{ Hz to } 100\text{ kHz}$		500		μV
Bias current	$I_O = 750\text{ mA}$		60	75	mA
	$I_O = 10\text{ mA}$			5	
Bias current (TL751Mxx only)	$\overline{\text{ENABLE}} V_{IH} \geq 2\text{ V}$			200	μA

NOTE 3: Pulse-testing techniques maintain the junction temperature as close to the ambient temperature as possible. Thermal effects must be taken into account separately. All characteristics are measured with a 0.1- μF capacitor across the input and a 10- μF tantalum capacitor on the output, with equivalent series resistance within the guidelines shown in Figure 3.



TL750M, TL751M SERIES LOW-DROPOUT VOLTAGE REGULATORS

SLVS021H – JANUARY 1988 – REVISED JANUARY 2000

electrical characteristics, $V_I = 14\text{ V}$, $I_O = 300\text{ mA}$, $\overline{\text{ENABLE}}$ at 0 V for TL751M10, $T_J = 25^\circ\text{C}$ (unless otherwise noted) (see Note 3)

PARAMETER	TEST CONDITIONS	TL750M10C TL751M10C			UNIT
		MIN	TYP	MAX	
Output voltage		9.9	10	10.1	V
	$T_J = 0^\circ\text{C to } 125^\circ\text{C}$	9.8		10.2	
Input voltage regulation	$V_I = 12\text{ V to } 18\text{ V}$, $I_O = 250\text{ mA}$		15	43	mV
	$V_I = 11\text{ V to } 26\text{ V}$, $I_O = 250\text{ mA}$		20	75	
Ripple rejection	$V_I = 13\text{ V to } 23\text{ V}$, $f = 120\text{ Hz}$	50	55		dB
Output voltage regulation	$I_O = 5\text{ mA to } 750\text{ mA}$		30	100	mV
Dropout voltage	$I_O = 500\text{ mA}$			0.5	V
	$I_O = 750\text{ mA}$			0.6	
Output noise voltage	$f = 10\text{ Hz to } 100\text{ kHz}$		1000		μV
Bias current	$I_O = 750\text{ mA}$		60	75	mA
	$I_O = 10\text{ mA}$			5	
Bias current (TL751Mxx only)	$\overline{\text{ENABLE}} V_{IH} \geq 2\text{ V}$			200	μA

NOTE 3: Pulse-testing techniques maintain the junction temperature as close to the ambient temperature as possible. Thermal effects must be taken into account separately. All characteristics are measured with a $0.1\text{-}\mu\text{F}$ capacitor across the input and a $10\text{-}\mu\text{F}$ tantalum capacitor on the output, with equivalent series resistance within the guidelines shown in Figure 3.

electrical characteristics, $V_I = 14\text{ V}$, $I_O = 300\text{ mA}$, $\overline{\text{ENABLE}}$ at 0 V for TL751M12, $T_J = 25^\circ\text{C}$ (unless otherwise noted) (see Note 3)

PARAMETER	TEST CONDITIONS	TL750M12C TL751M12C			UNIT
		MIN	TYP	MAX	
Output voltage		11.88	12	12.12	V
	$T_J = 0^\circ\text{C to } 125^\circ\text{C}$	11.76		12.24	
Input voltage regulation	$V_I = 14\text{ V to } 19\text{ V}$, $I_O = 250\text{ mA}$		15	43	mV
	$V_I = 13\text{ V to } 26\text{ V}$, $I_O = 250\text{ mA}$		20	78	
Ripple rejection	$V_I = 13\text{ V to } 23\text{ V}$, $f = 120\text{ Hz}$	50	55		dB
Output voltage regulation	$I_O = 5\text{ mA to } 750\text{ mA}$		30	120	mV
Dropout voltage	$I_O = 500\text{ mA}$			0.5	V
	$I_O = 750\text{ mA}$			0.6	
Output noise voltage	$f = 10\text{ Hz to } 100\text{ kHz}$		1000		μV
Bias current	$I_O = 750\text{ mA}$		60	75	mA
	$I_O = 10\text{ mA}$			5	
Bias current (TL751Mxx only)	$\overline{\text{ENABLE}} V_{IH} \geq 2\text{ V}$			200	μA

NOTE 3: Pulse-testing techniques maintain the junction temperature as close to the ambient temperature as possible. Thermal effects must be taken into account separately. All characteristics are measured with a $0.1\text{-}\mu\text{F}$ capacitor across the input and a $10\text{-}\mu\text{F}$ tantalum capacitor on the output, with equivalent series resistance within the guidelines shown in Figure 3.



TL750M, TL751M SERIES LOW-DROPOUT VOLTAGE REGULATORS

SLVS021H – JANUARY 1988 – REVISED JANUARY 2000

electrical characteristics, $V_I = 14\text{ V}$, $I_O = 300\text{ mA}$, $\overline{\text{ENABLE}}$ at 0 V , $T_J = 25^\circ\text{C}$ (unless otherwise noted) (see Note 3)

PARAMETER	TEST CONDITIONS	TL750M05Y			UNIT
		MIN	TYP	MAX	
Output voltage			5		V
Input voltage regulation	$V_I = 9\text{ V to }16\text{ V}$, $I_O = 250\text{ mA}$		10		mV
	$V_I = 6\text{ V to }26\text{ V}$, $I_O = 250\text{ mA}$		12		
Ripple rejection	$V_I = 8\text{ V to }18\text{ V}$, $f = 120\text{ Hz}$		55		dB
Output voltage regulation	$I_O = 5\text{ mA to }750\text{ mA}$		20		mV
Output noise voltage	$f = 10\text{ Hz to }100\text{ kHz}$		500		μV
Bias current	$I_O = 750\text{ mA}$		60		mA

NOTE 3: Pulse-testing techniques maintain the junction temperature as close to the ambient temperature as possible. Thermal effects must be taken into account separately. All characteristics are measured with a 0.1- μF capacitor across the input and a 10- μF tantalum capacitor on the output, with equivalent series resistance within the guidelines shown in Figure 3.

electrical characteristics, $V_I = 14\text{ V}$, $I_O = 300\text{ mA}$, $\overline{\text{ENABLE}}$ at 0 V , $T_J = 25^\circ\text{C}$ (unless otherwise noted) (see Note 3)

PARAMETER	TEST CONDITIONS	TL750M08Y			UNIT
		MIN	TYP	MAX	
Output voltage			8		V
Input voltage regulation	$V_I = 10\text{ V to }17\text{ V}$, $I_O = 250\text{ mA}$		12		mV
	$V_I = 9\text{ V to }26\text{ V}$, $I_O = 250\text{ mA}$		15		
Ripple rejection	$V_I = 11\text{ V to }21\text{ V}$, $f = 120\text{ Hz}$		55		dB
Output voltage regulation	$I_O = 5\text{ mA to }750\text{ mA}$		24		mV
Output noise voltage	$f = 10\text{ Hz to }100\text{ kHz}$		500		μV
Bias current	$I_O = 750\text{ mA}$		60		mA

NOTE 3: Pulse-testing techniques maintain the junction temperature as close to the ambient temperature as possible. Thermal effects must be taken into account separately. All characteristics are measured with a 0.1- μF capacitor across the input and a 10- μF tantalum capacitor on the output, with equivalent series resistance within the guidelines shown in Figure 3.

electrical characteristics, $V_I = 14\text{ V}$, $I_O = 300\text{ mA}$, $\overline{\text{ENABLE}}$ at 0 V , $T_J = 25^\circ\text{C}$ (unless otherwise noted) (see Note 3)

PARAMETER	TEST CONDITIONS	TL750M10Y			UNIT
		MIN	TYP	MAX	
Output voltage			10		V
Input voltage regulation	$V_I = 12\text{ V to }18\text{ V}$, $I_O = 250\text{ mA}$		15		mV
	$V_I = 11\text{ V to }26\text{ V}$, $I_O = 250\text{ mA}$		20		
Ripple rejection	$V_I = 13\text{ V to }23\text{ V}$, $f = 120\text{ Hz}$		55		dB
Output voltage regulation	$I_O = 5\text{ mA to }750\text{ mA}$		30		mV
Output noise voltage	$f = 10\text{ Hz to }100\text{ kHz}$		1000		μV
Bias current	$I_O = 750\text{ mA}$		60		mA

NOTE 3: Pulse-testing techniques maintain the junction temperature as close to the ambient temperature as possible. Thermal effects must be taken into account separately. All characteristics are measured with a 0.1- μF capacitor across the input and a 10- μF tantalum capacitor on the output, with equivalent series resistance within the guidelines shown in Figure 3.



TL750M, TL751M SERIES LOW-DROPOUT VOLTAGE REGULATORS

SLVS021H – JANUARY 1988 – REVISED JANUARY 2000

TL751M12Y electrical characteristics, $V_I = 14\text{ V}$, $I_O = 300\text{ mA}$, $\overline{\text{ENABLE}}$ at 0 V , $T_J = 25^\circ\text{C}$ (unless otherwise noted) (see Note 3)

PARAMETER	TEST CONDITIONS	TL750M12Y			UNIT
		MIN	TYP	MAX	
Output voltage			12		V
Input voltage regulation	$V_I = 14\text{ V to }19\text{ V}$, $I_O = 250\text{ mA}$		15		mV
	$V_I = 13\text{ V to }26\text{ V}$, $I_O = 250\text{ mA}$		20		
Ripple rejection	$V_I = 13\text{ V to }23\text{ V}$, $f = 120\text{ Hz}$		55		dB
Output voltage regulation	$I_O = 5\text{ mA to }750\text{ mA}$		30		mV
Output noise voltage	$f = 10\text{ Hz to }100\text{ kHz}$		1000		μV
Bias current	$I_O = 750\text{ mA}$		60		mA

NOTE 3: Pulse-testing techniques maintain the junction temperature as close to the ambient temperature as possible. Thermal effects must be taken into account separately. All characteristics are measured with a $0.1\text{-}\mu\text{F}$ capacitor across the input and a $10\text{-}\mu\text{F}$ tantalum capacitor on the output, with equivalent series resistance within the guidelines shown in Figure 3.

PARAMETER MEASUREMENT INFORMATION

The TL751Mxx is a low-dropout regulator. This means that the capacitance loading is important to the performance of the regulator because it is a vital part of the control loop. The capacitor value and the equivalent series resistance (ESR) both affect the control loop and must be defined for the load range and the temperature range. Figures 1 and 2 can establish the capacitance value and ESR range for the best regulator performance.

Figure 1 shows the recommended range of ESR for a given load with a $10\text{-}\mu\text{F}$ capacitor on the output. This figure also shows a maximum ESR limit of $2\ \Omega$ and a load-dependent minimum ESR limit.

For applications with varying loads, the lightest load condition should be chosen because it is the worst case. Figure 2 shows the relationship of the reciprocal of ESR to the square root of the capacitance with a minimum capacitance limit of $10\ \mu\text{F}$ and a maximum ESR limit of $2\ \Omega$. This figure establishes the amount that the minimum ESR limit shown in Figure 1 can be adjusted for different capacitor values. For example, where the minimum load needed is 200 mA , Figure 2 suggests an ESR range of $0.8\ \Omega$ to $2\ \Omega$ for $10\ \mu\text{F}$. Figure 2 shows that changing the capacitor from $10\ \mu\text{F}$ to $400\ \mu\text{F}$ can change the ESR minimum by greater than $3/0.5$ (or 6). Therefore, the new minimum ESR value is $0.8/6$ (or $0.13\ \Omega$). This allows an ESR range of $0.13\ \Omega$ to $2\ \Omega$, achieving an expanded ESR range by using a larger capacitor at the output. For better stability in low-current applications, a small resistance placed in series with the capacitor (see Table 1) is recommended, so that ESRs better approximate those shown in Figures 1 and 2.

TL750M, TL751M SERIES LOW-DROPOUT VOLTAGE REGULATORS

SLVS021H – JANUARY 1988 – REVISED JANUARY 2000

PARAMETER MEASUREMENT INFORMATION

Table 1. Compensation for Increased Stability at Low Currents

MANUFACTURER	CAPACITANCE	ESR TYP	PART NUMBER	ADDITIONAL RESISTANCE
AVX	15 μF	0.9 Ω	TAJB156M010S	1 Ω
KEMET	33 μF	0.6 Ω	T491D336M010AS	0.5 Ω

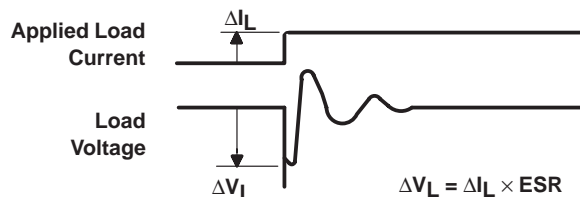

OUTPUT CAPACITOR
EQUIVALENT SERIES RESISTANCE (ESR)
vs
LOAD CURRENT RANGE

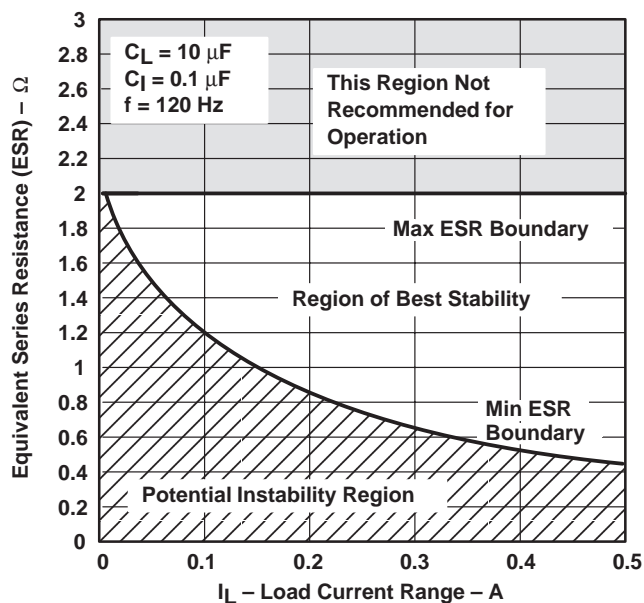

Figure 1

STABILITY
vs
EQUIVALENT SERIES RESISTANCE (ESR)

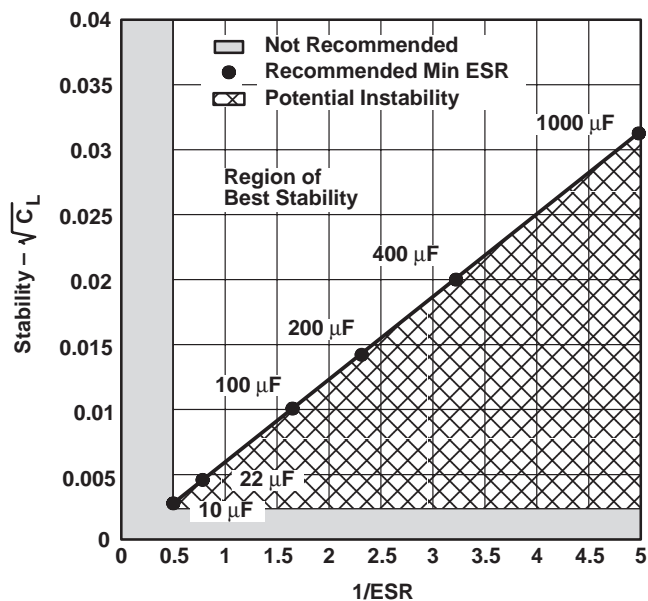

Figure 2

TYPICAL CHARACTERISTICS

Table of Graphs

		FIGURE
Transient input voltage vs Time		3
Output voltage vs Input voltage		4
Input current vs Input voltage	$I_O = 10 \text{ mA}$	5
	$I_O = 100 \text{ mA}$	6
Dropout voltage vs Output current		7
Quiescent current vs Output current		8
Load transient response		9
Line transient response		10

TRANSIENT INPUT VOLTAGE
vs
TIME

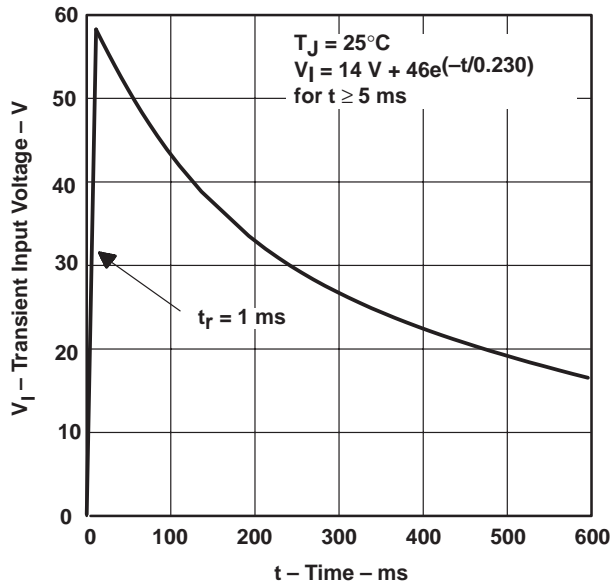

Figure 3

OUTPUT VOLTAGE
vs
INPUT VOLTAGE

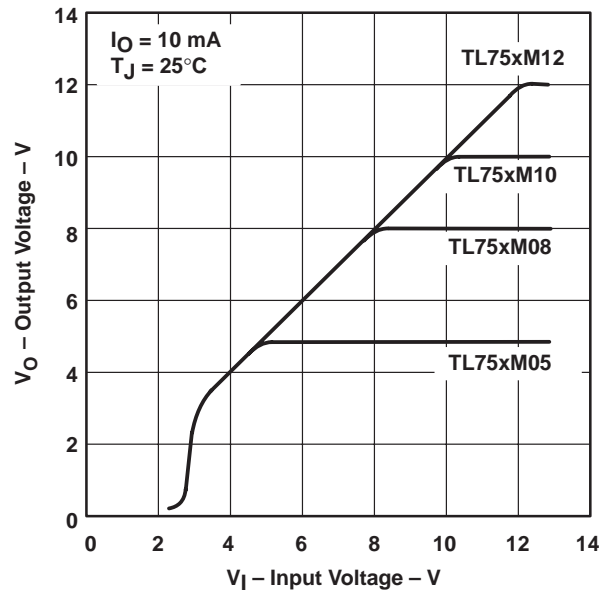
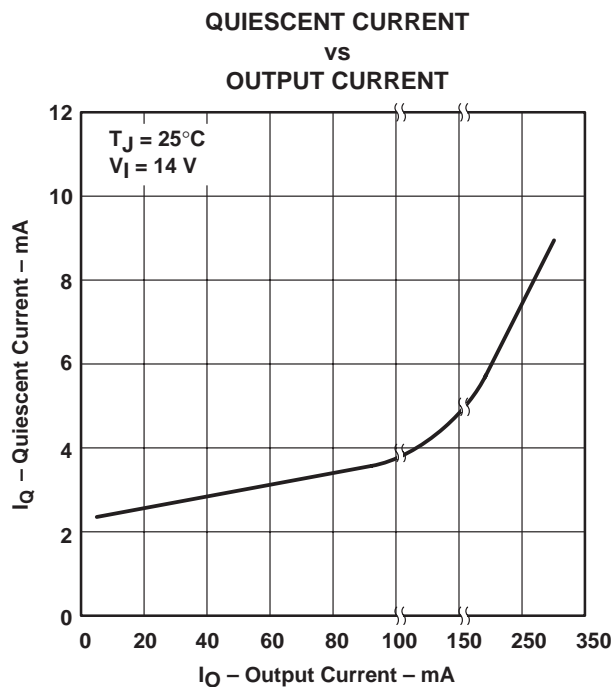
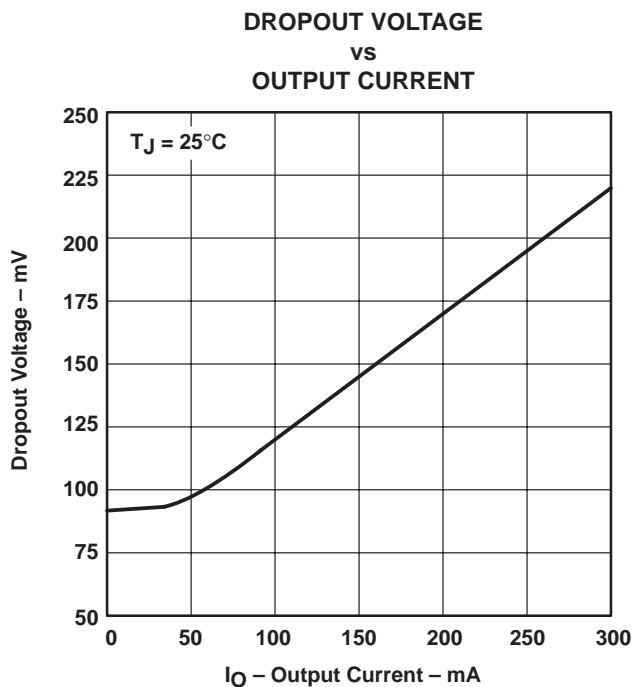
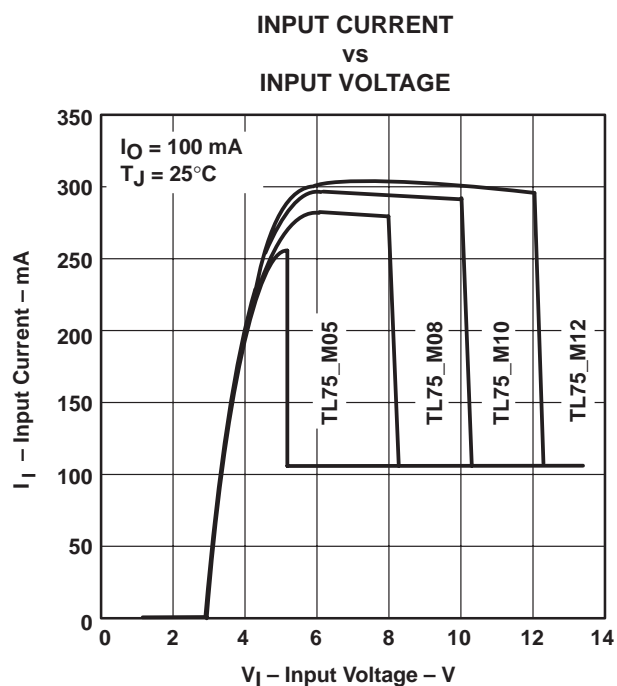
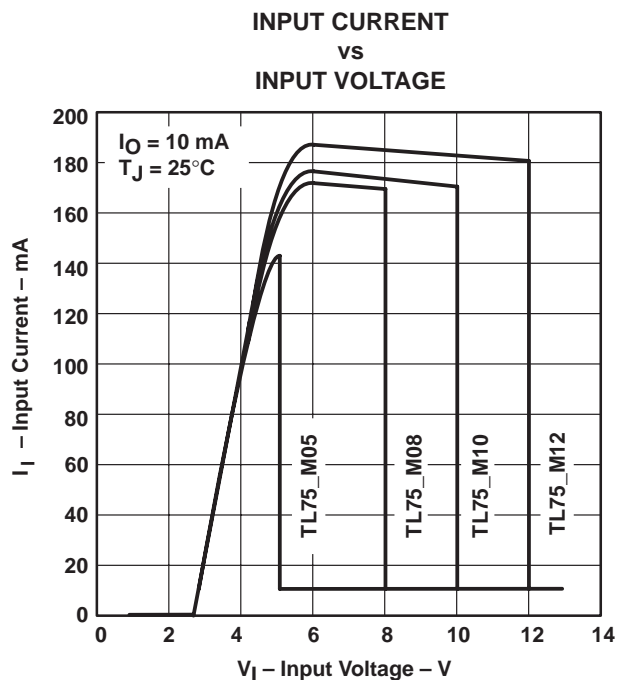

Figure 4

TL750M, TL751M SERIES LOW-DROPOUT VOLTAGE REGULATORS

SLVS021H – JANUARY 1988 – REVISED JANUARY 2000

TYPICAL CHARACTERISTICS



TYPICAL CHARACTERISTICS

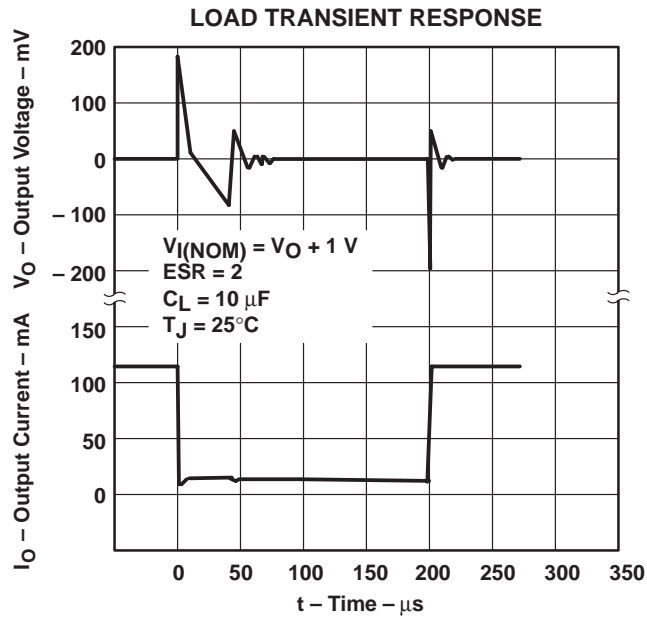

Figure 9

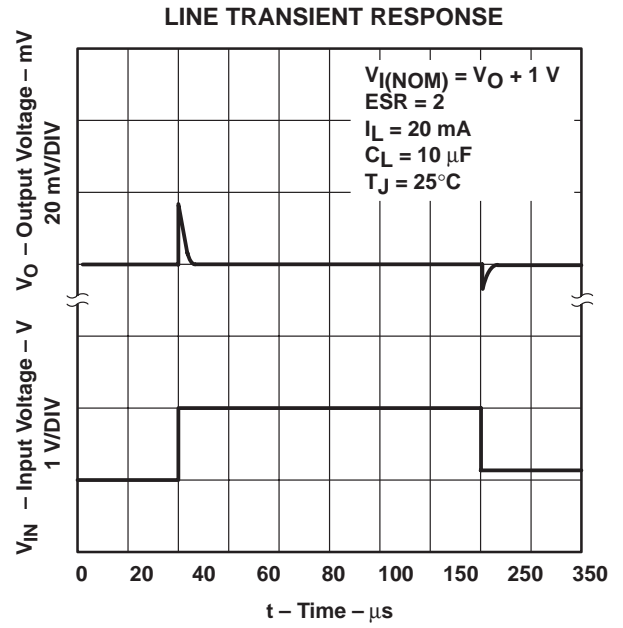

Figure 10

IMPORTANT NOTICE

Texas Instruments and its subsidiaries (TI) reserve the right to make changes to their products or to discontinue any product or service without notice, and advise customers to obtain the latest version of relevant information to verify, before placing orders, that information being relied on is current and complete. All products are sold subject to the terms and conditions of sale supplied at the time of order acknowledgement, including those pertaining to warranty, patent infringement, and limitation of liability.

TI warrants performance of its semiconductor products to the specifications applicable at the time of sale in accordance with TI's standard warranty. Testing and other quality control techniques are utilized to the extent TI deems necessary to support this warranty. Specific testing of all parameters of each device is not necessarily performed, except those mandated by government requirements.

CERTAIN APPLICATIONS USING SEMICONDUCTOR PRODUCTS MAY INVOLVE POTENTIAL RISKS OF DEATH, PERSONAL INJURY, OR SEVERE PROPERTY OR ENVIRONMENTAL DAMAGE ("CRITICAL APPLICATIONS"). TI SEMICONDUCTOR PRODUCTS ARE NOT DESIGNED, AUTHORIZED, OR WARRANTED TO BE SUITABLE FOR USE IN LIFE-SUPPORT DEVICES OR SYSTEMS OR OTHER CRITICAL APPLICATIONS. INCLUSION OF TI PRODUCTS IN SUCH APPLICATIONS IS UNDERSTOOD TO BE FULLY AT THE CUSTOMER'S RISK.

In order to minimize risks associated with the customer's applications, adequate design and operating safeguards must be provided by the customer to minimize inherent or procedural hazards.

TI assumes no liability for applications assistance or customer product design. TI does not warrant or represent that any license, either express or implied, is granted under any patent right, copyright, mask work right, or other intellectual property right of TI covering or relating to any combination, machine, or process in which such semiconductor products or services might be or are used. TI's publication of information regarding any third party's products or services does not constitute TI's approval, warranty or endorsement thereof.